

COLOR | SHAPE | TRIMS

MARCHÉ

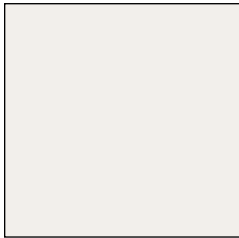

Powder (gloss)



Paper (matte)



Summer (gloss)



Sand (matte)



Snow White

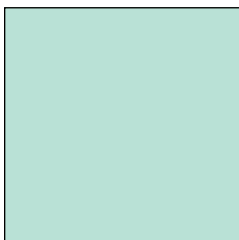

Crystal (gloss)

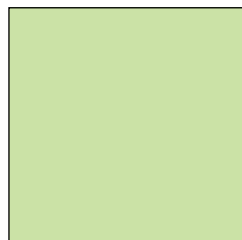

Fresh Green (gloss)



Feather (gloss)

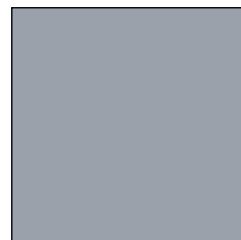

Slate (matte)

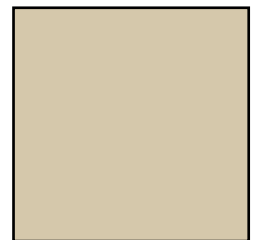

Sahara (gloss)

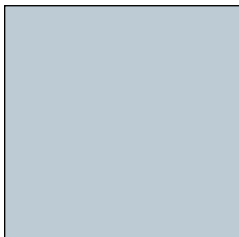

Frost (gloss)



Deep Blue (gloss)

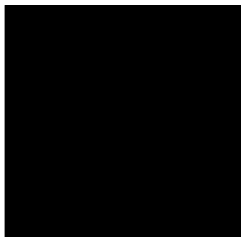

Black (gloss)



Black (matte)



Strawberry (matte)

The colors printed on this page are not exact. Please request a current glaze sample.

This information guide has been developed to help our customers better understand the range of usage and variance inherent in each glaze. We see this information as general information.

Variation In Shading

Below we have listed each glaze and its' relative variance. #5 would represent a white glaze with the least amount of variance. #1 would represent a colored crackle that might have the most amount of variance. Special notes will include; descriptions of how dark colored crackles will pool on decos, liners, and molding details.

1. **Limited Variation** - These colors show little or no variation and are very stable shipment to shipment. Blending during installation is recommended.

Note: All mattes are made from commercial glaze base and require no sealing.

2.- 3. **Medium Variation** - Similar in description to wide variation but less than half the occurrence. Caps and decos show less shading variance in areas of pooling. Variation shipment to shipment almost non-existent. Blending during installation is highly recommended.

4.- 5. **Wide Variation** - This is typical of Dark Crackles and Translucent Tints. May also be very evident in areas pooling on molding and deco pieces. Color tones and shades may vary from shipment to shipment. As with any tile blending during installation is highly recommended.

Durability And Suitable Application Areas

1. **Light duty** - Intended for interior residential vertical surface installation. May also include commercial use in similar vertical surface applications depending on intended use of space.

2. **Medium duty** - Intended for use on most residential vertical surfaces and includes some horizontal applications. May also apply to light duty vertical commercial applications. Residentially this includes shower walls, bathroom walls, kitchen back splashes and some light use kitchen counter tops*.

3. **Heavy duty** - would apply to all interior residential floor, counter top*, and wall applications.

* Light use kitchen counter tops are defined as infrequently used for extensive cooking. Note: Dark gloss glazes should never be specified on counter top applications.

NAME	NUMBER	TYPE	VARIATION	DURABILITY	NAME	NUMBER	TYPE	VARIATION	DURABILITY
SAND	M291	MATTE	2	2	POWDER	G289	GLOSS	2	1
PAPER	M292	MATTE	2	2	SUMMER	G290	GLOSS	2	1
STRAWBERRY	M398	MATTE	2	2	FRESH GREEN	G396	GLOSS	2	1
SLATE	M399	MATTE	2	2	CRYSTAL	G395	GLOSS	2	1
BLACK	M400	MATTE	2	2	SAHARA	G394	GLOSS	2	1
SNOW WHITE	C123-00	CRACKLE	2	1	DEEP BLUE	G393	GLOSS	2	1
					FROST	G397	GLOSS	2	1
					BLACK	G392	GLOSS	2	1

COLOR | SHAPE | TRIMS

MARCHÉ

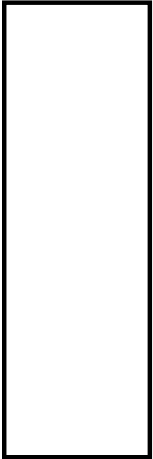

3x9
3x9BNL
3x9BNS
3x9DBNL
3x9DBNR

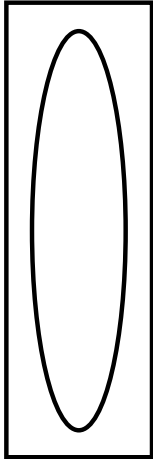

3x9Oval
3x9OvalBNL
3x9OvalBNS
3x9OvalDBNL
3x9OvalDBNR

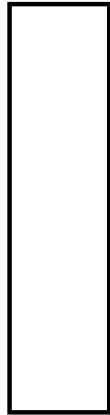

2x8
2x8BNL
2x8BNS
2x8DBNL
2x8DBNR

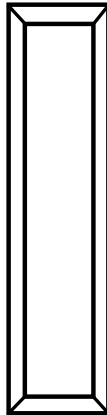

2x8Bevel
2x8BevelBNL
2x8BevelBNS
2x8BevelDBNL
2x8BevelDBNR

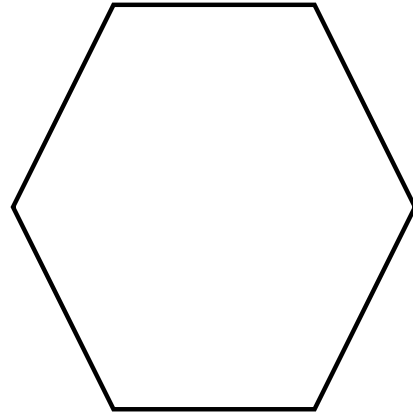

8x8Hex

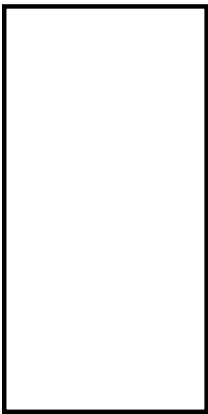

4x8
4x8BNL
4x8BNS
4x8DBNL
4x8DBNR

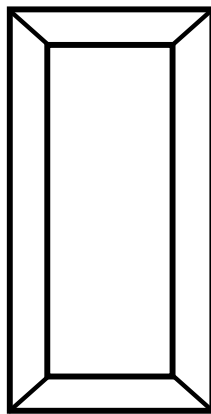

4x8Bevel
4x8BevelBNL
4x8BevelBNS
4x8BevelDBNL
4x8BevelDBNR

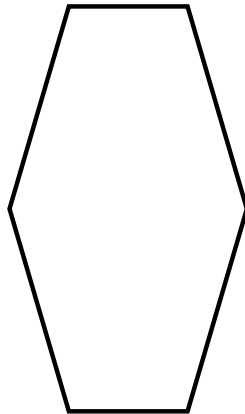

3x6x8 El Hex



6x12
6x12BNL
6x12BNS
6x12DBNL
6x12DBNR

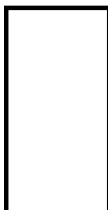

2x4
2x4BNL
2x4BNS
2x4DBNL
2x4DBNR

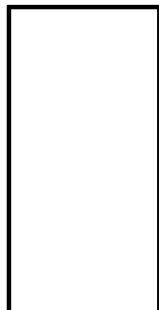

3x6
3x6BNL
3x6BNS
3x6DBNL
3x6DBNR

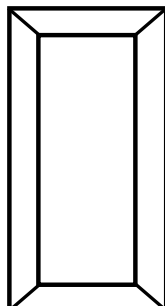

3x6Bevel
3x6BevelBNL
3x6BevelBNS
3x6BevelDBNL
3x6BevelDBNR

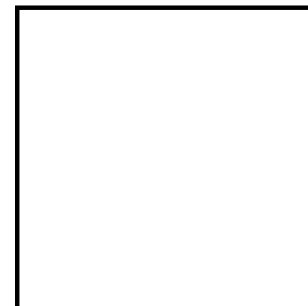

6x6
6x6BN
6x6DBN

COLOR | SHAPE | TRIMS

MARCHÉ

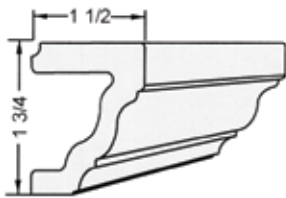

P2xCap

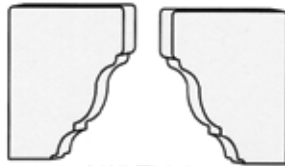

Left 3/8" Thick Right

P2xCap Full Stops

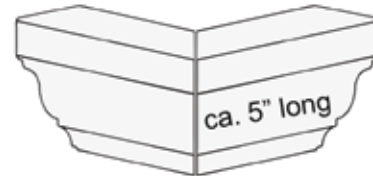

P2xCap mitered Crrr
(2 pieces - 2"x 5" ea.)

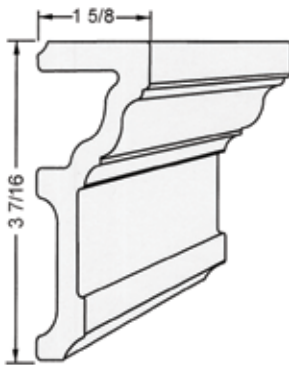

P3xCap

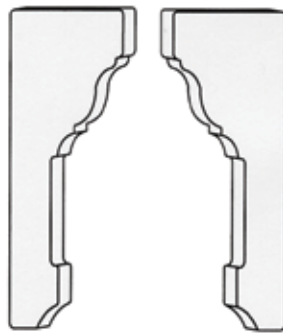

Left 3/8" Thick Right

P3xCap Full Stops



P3xCap mitered Crrr
(2 pieces - 3"x 5" ea.)

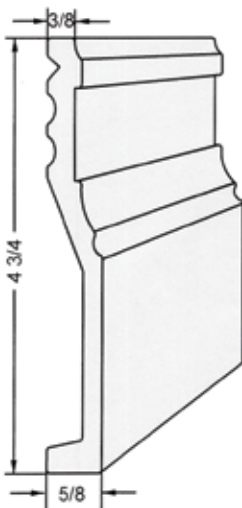

P6xBase

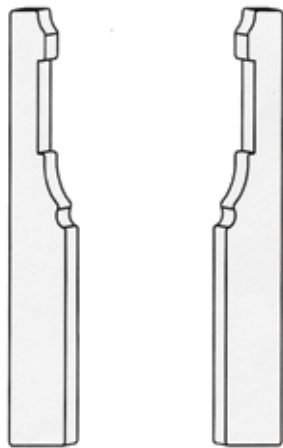

Left 3/8" Thick Right

P6xBase Full Stops

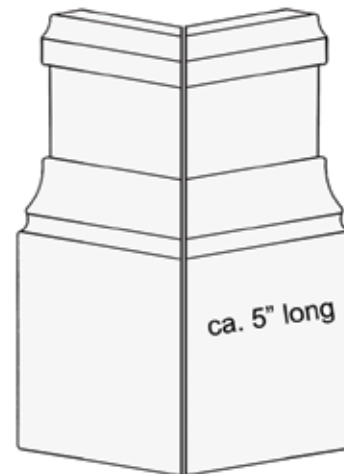

P6xBase mitered Crrr
(2 pieces - 4.75"x 5" ea.)

Outside Corners are two (2) mitered pieces - almost two full length pieces.

Quarry Tile Co., 6328 East Utah Ave, Spokane, WA 99212 | ph: 800.423.2608 | fx: 509.536.4072

COLOR | SHAPE | TRIMS

MARCHÉ

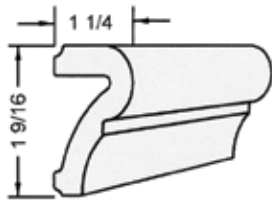

V1.5xCap



Left 3/8" Thick Right
V1.5xCap Full Stops

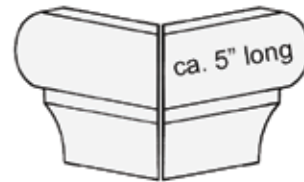

V1.5xCap mitered Cmr
(2 pieces - 1.5"x 5" ea.)

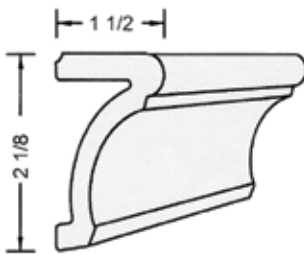

V2.5xCap



Left 3/8" Thick Right
V2.5xCap Full Stops

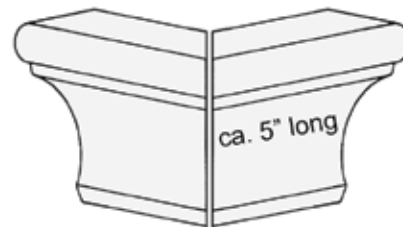

V2.5xCap mitered Cmr
(2 pieces - 2.5"x 5" ea.)

Outside Corners are two (2) mitered pieces - almost two full length pieces.

COVE BASE

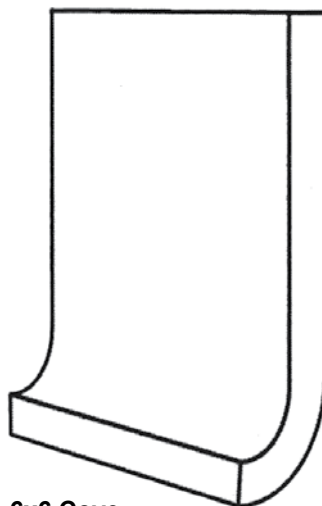

6x6 Cove

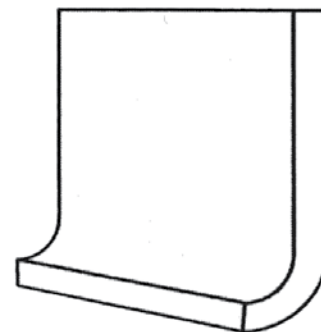

3x6 Cove

Quarry Tile Co., 6328 East Utah Ave, Spokane, WA 99212 | ph: 800.423.2608 | fx: 509.536.4072

COLOR | SHAPE | TRIMS

MARCHÉ

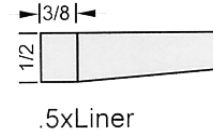
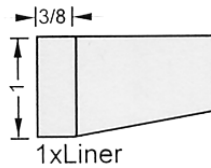
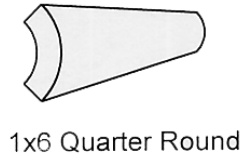
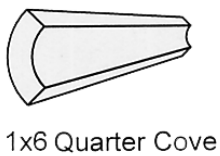
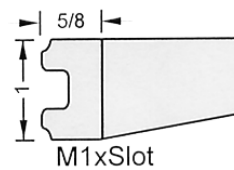
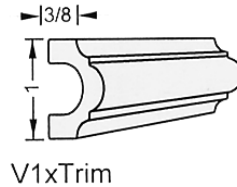
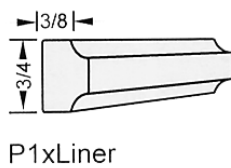
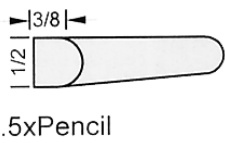
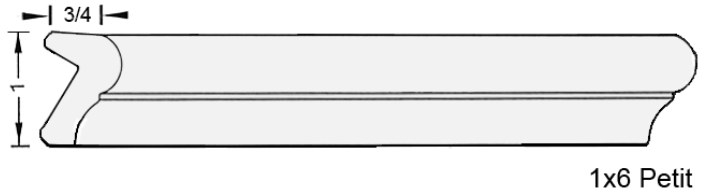
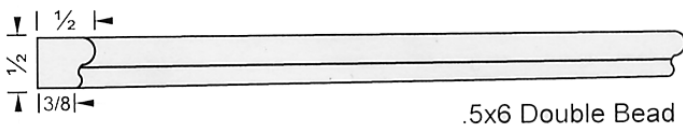
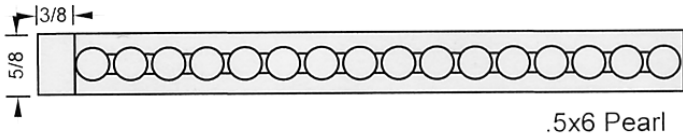

Quarry Tile Co., 6328 East Utah Ave, Spokane, WA 99212 | ph: 800.423.2608 | fx: 509.536.4072